

Model: **VTLF2.200**

SPECIFICATIONS

Volume flow 50 Hz	178 m ³ /h
Vacuum absolute 50 Hz	200 mbar
Power 50 Hz	4.0 kW
Noise Level 50 Hz	75.0 dB(A)
Volume flow 60 Hz	218 m ³ /h
Vacuum absolute 60 Hz	200 mbar
Power 60 Hz	4.8 kW
Noise Level 60 Hz	77.0 dB(A)
Weight	151.0 kg without motor

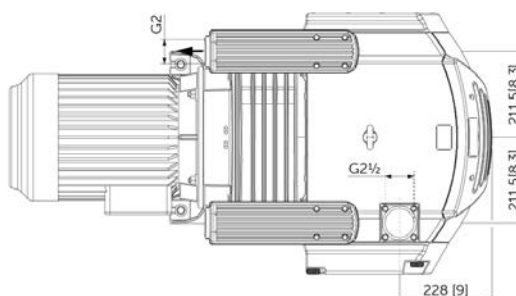
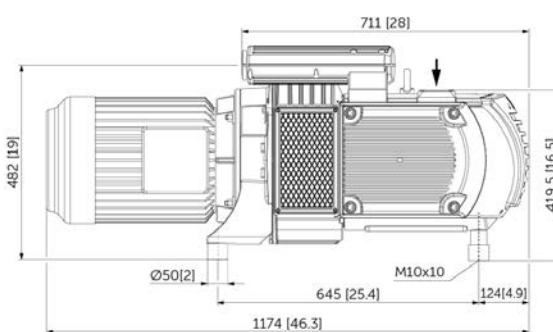
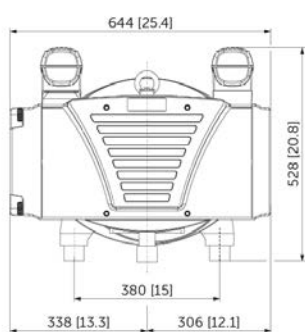

mm [inch]

BECKER VTLF 2.200